2011

R4 Series User Manual



Forwell Wireless Ltd.

2011-4-27

Copyright Declaration

“倚天丰华®” and **Forwell** 倚天丰华 are registered trademarks of Shenzhen Forwell Wireless Co., Ltd. The copyright of all the product parts, including accessories and the software, belongs to Shenzhen Forwell Wireless Co., Ltd. Without the permission of Shenzhen Forwell Wireless Co., Ltd, any copy and translating is not allowed.

All the pictures and specifications of the product are just for reference, which will have tiny difference with the upgrading of the product. If there is any change of the product, we will not give further notice. If you want to know more about the product, please visit our website: <http://www.forwellwireless.com>

Sales	Phone	+86-755-26624211
	E-mail	sales@forwellwireless.com
	FAX	+86-755-26621490
Post	2-4A, Chaguang Industrial Park, Nanshan District, Shenzhen, Guangdong Province P.R. China	
Web	http://www.forwellwireless.com	

Catalog

Chapter 1	Instruction Manual Introduction.....	
1.1	Purpose.....	
1.2	Application Fields.....	
1.3	Version Information	
1.4	Technical Support.....	
Chapter 2	Product Introduction.....	
2.1	Brief Introduction to the Products.....	
2.2	function features.....	
2.3	application Fields	
2.4	Product model	
Chapter 3	Hardware Installation	
3.1	Overall Dimension.....	
3.2	Accessories Description	
3.3	Installment	
3.3.1	SIM/UIM card installed.....	
3.3.2	The installation of terminal blocks	
3.3.3	Terminal signal definition	
3.3.4	Grounding	
3.3.6	Check Network Status.....	
Chapter 4	Software configuration.....	
4.1	Overview	
4.2	How to log into the Router	
4.2.1	network Configuration of the Computer	
4.2.2	log into Router	
4.3	How to config web.....	
4.3.1	Main Menu as below Picture	
4.3.2	Operation Mode.....	
4.3.3	WAN Settings	
4.3.4	LAN Settings	
4.3.5	DHCP Client	
4.3.6	Configure Static Routing.....	
4.3.7	VPN.....	
4.3.7.1	IPSEC	
4.3.7.2	PPTP	
4.3.7.3	L2TP	
4.3.8	DTU Settings	
4.3.9	SMS/Voice Control (it is only used for R46B/R49B)	
4.3.10	GPS(OPTIONAL)	29
4.3.10	Wireless settings.....	

4.3.11	Firewall
4.3.12	Administration

Chapter 1 Instruction Manual Introduction

This chapter is about the related operation information of the R4 Routers. It is the best instruction manual for installing and using R4 series.

1. Purpose
2. Application Fields
3. Version Information
4. Technical Support

1.1 Purpose

This Instruction Manual is mainly for the installation and test of the R4 series of Forwell Wireless.

1.2 Application Fields

This Instruction Manual is suitable for the users who has certain knowledge of computer network and electronic technology, network device administrators and other management personnel who need to use R4 series.

1.2 Version Information

According to the requirement of the market and the users, we will make some functional adjustment and technical improvement to the R4 series. Below table includes all the versions of the R4 series of Forwell Wireless and revision reasons in different periods.

Table-1.1: Version Information

Version No.	Revision Department	Related Department	Date	Revised Content
1.0.0	R&D Center	Sales, Technical Engineer	2010.12	First publish
2.0.0	R&D Center	Sales, Technical Engineer	2011.1	Add some function and make adjustments

				to hardware
2.1.1	R&D Center	Sales, Technical Engineer	2011.3	Add function

1.3 Technical Support

In order to solve the problems more quickly. Please contact us by:



Tel:

Service Hot-line: 0755-88839200



E-mail:

Technical Support: support@forwellwireless.com

For more information, please visit our website www.forwellwireless.com.

Chapter 2 Product Introduction

This chapter mainly describes the function of R4 series and field of application.

1. *Brief Introduction*
2. *features*
3. *application*
4. *Product model*

2.1 Brief Introduction

With the development of mobile communication technology, the mobile data communication network using GPRS/CDMA/EDGE/EVDO/TD-SCDMA/HSDPA/HSUPA has covered many regions in the world. And network is very stable. All these make a larger market for wireless terminals. Because different industries have different applications and different information needs, so the industry application solutions provided by the mobile communication operators must satisfy both the common needs and the special individual needs of the industry users perfectly. Therefore, in recent two years, based on the needs of industry users, Telecommunication, Telecom Operator do innovative practice energetically in mobile application and provide solutions to meet the unique needs of the users. Being different with the popular data requirements, industry application is very professional. Different industry users need different terminals. So hardware and software development and system integration must be accord with different industry needs. So by analysing the different industry application features in recent years and according to the network features and the actual condition of the network operators, Forwell Wireless Ltd launched the individually designed R4 series.

R4 series provide users the high-speed, always-online and transparent-data-transmission communication network. In order to meet the needs of Electronic Power System Automation, Industry Monitoring, Transportation Management, Weather, Environment Protection, Pipe Network Monitoring, Finance and Bond industries, by using 2G/3G network R4 series achieve the transparent data transmission function. In the meantime, considering the network needs of every department, on the basis of R4 series developed the R4 products which have RS232/485 interface are high-performance, industry-use and external.



2.2 function features

- Supports EV-DO RevA/Rev0, 1xRTT, HSUPA, HSDPA, UMTS, EDGE & GPRS network
- 1 port 10/100 Ethernet LAN switch with LAN / DMZ configurable zones
- 3G module Built-in
- Support WiFi 802.11b/g/n
- RS-232 port offer a transparent channel for M2M application
- IPSec-based VPN client w/DES, 3DES, AES
- Stateful Packet Inspection Firewall
- Supports dynamic or static IP addresses assigned by cellular carriers
- Support APN/VPDN network

2.3 application Fields

- Video Surveillance

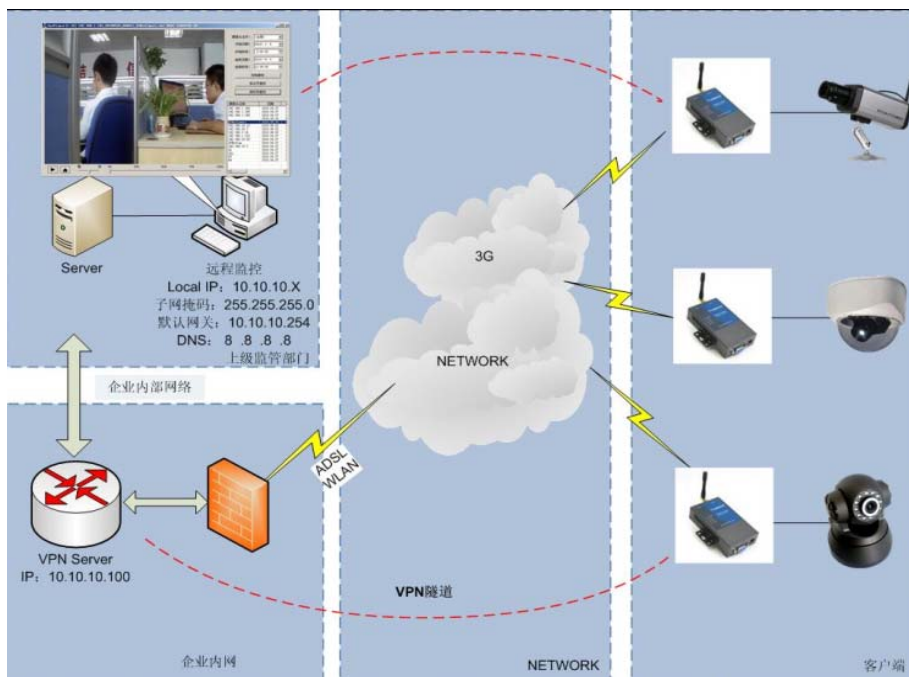

➤ Financial Service(ATM&POS)

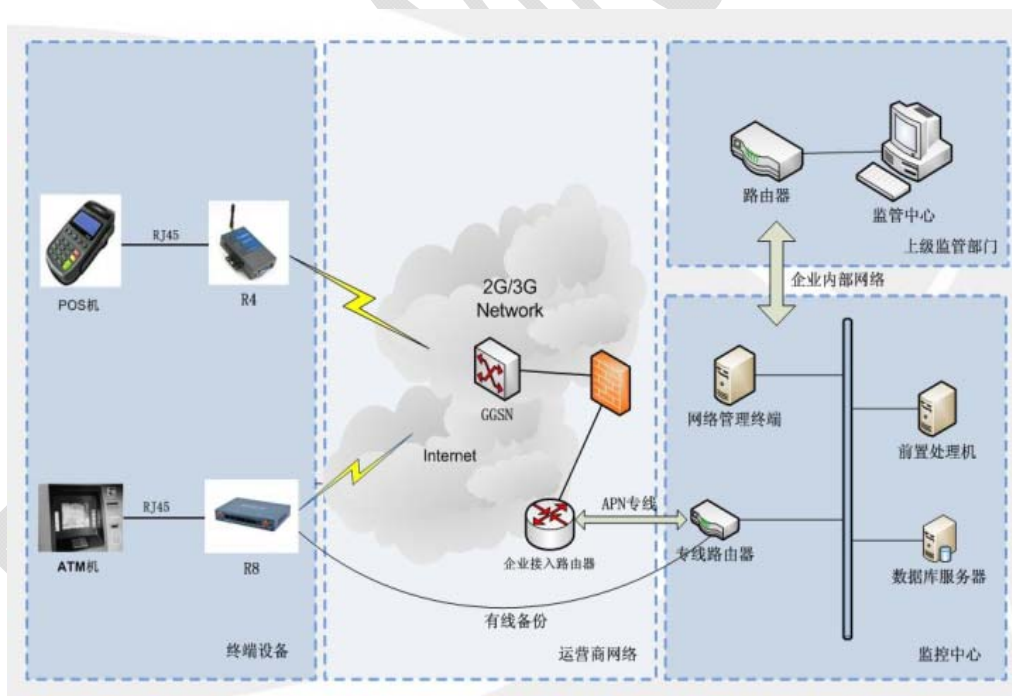

2.4 Product model

- R49 HSUPA Router
- R48 TDSCDMA Router
- R47 HSDPA Router
- R46 EVDO revA Router

R461Y232 EVDO revA Router
R44 EDGE Router
R43 CDMA Router
R42 GPRS Router

Chapter 3 Hardware Installation



This chapter mainly describes the appearance, model and function of R4 series and how to install and set the configurations.

1. Overall Dimension
2. Accessories Description
3. Installment

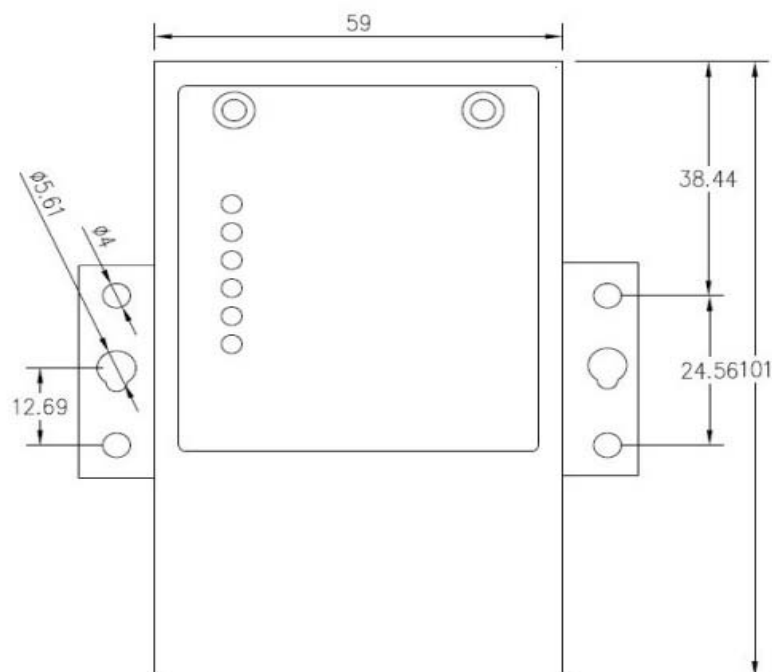
3.1 Overall Dimension



3.2 Accessories Description

Name	Entires	Quantity	Describe	Picture
Device	piece	1	Standard	
Power	piece	1	12V1A	
antenna	piece	2	Standard	
Network cable	piece	1	Standard	
Usermanual	piece	1	Standard	CD-ROM

3.3 Installment

R4 series should be installed and configured properly before putting in service. The installation and configuration should be done or supervise by qualified engineer.

Attention:

Don't install R4 series or connect/disconnect its cable when it is power on.

3.3.1 SIM/UIM card installed

Before loading SIM/UIM card, please open back cover. Up gently, gap outwards, press to make the card fixed.

Attention: *SIM/UIM card does not reach the designated position, the equipment can not find a card, can't work normally.*



3.3.2 The installation of terminal blocks

R4 use pluggable terminals to connect the user's data and the power supply. Spacing: 3.81mm, 10 Pin; user data and power supply suggestion: 14~24AWG. Please refer to the Table 2-4 for the interface definition of the power cable and connection sequence. Specific interface definition of the power cable and connection sequence you can read on the labels of R4 products.

Using 14~24AWG cable and referring to R4 products labels or the belowed interface definition and connection sequence, you need to use the oblate screw driver to fix the cable to the connecting jacks of the pluggable terminal. After successfully connection, you need to insert the terminal into the corresponding position in the bottom of the R4 products.

Notes: Connection sequence should be accurate. Cable's insulating striping length is about 7mm. (For safety, insulating striping length should be not too long.). please refer to the picture.



Attention:

1. The power cable should be connected correctly .We “suggest double check before switch it on .Wrong connections may destroy the equipment.
2. Power terminals:Pin 1 and Pin 2;
3. Here: Pin 2 is “GND”,PIN 1 is power input “Vin”(DC7~30V).

3.3.3 Terminal signal definition

PIN	Signal	Description	Note
1	Vin	+7-30V DC Input	Current: 12V/1A
2	GND	Ground	
3	Tx	Transmit	
4	Rx	Receive	
5	PGND	Ground	
6	Reset	Reset	Reset Pin has the same function with reset button. In the usage,it needs to be short connected to the GND. After giving the device a 1 sec low level, it will reboot.3 seconds, the device will restore factory settings
7	SPI-I (IO0)	General Purpose I/O	
8	SPI-O IO1)	General Purpose I/O	
9	SPI-CLK IO2)	General Purpose I/O	
10	SPI-EN IO3)	General Purpose I/O	

3.3.4 Grounding

To ensure a safe ,stable and reliable R4 series operation,Router cabinet should be grounded properly.

3.3.5 Power Supply

R4 series can be applied to complicated external environment and usually the power range is very large. So in order to fit the complicated application environment and improve the stability of the system, R4 series is designed with advanced power management technology. The DC power supply electronic to the device via the pluggable terminal PIN 2(GND) and PIN 1(Vin).Please refer to the above table for the detail definition of the terminal.

Normally, R4 series input powers supply is +7~+30V. the standard configuration is 12V/1A.

3.3.6 Check Network Status

Please connect the antenna after you successfully connect to the cable. And then insert the valid SIM/UIM card and provide the power to the R4 series via the cable. After provide the power to R4, if the RUN light start to blink in a few seconds, that means the system start-up is normal; if the Online light works, that means the network has been found; if the VPN light works, that means VPN tunnel has been set up. Please refer to the below table for the situation of the indication lights.

LED	Indication Light	Description
Run	On for 3 seconds	On for 3 seconds after power supply
	blink	System set-up normally
	Off or still on after 3 seconds	System set-up failure
Lan	blink	Data transmission in Ethernet
	Off	Ethernet connection abnormal
VPN	On	VPN tunnel set-up
	Off	VPN tunnel set-up failure

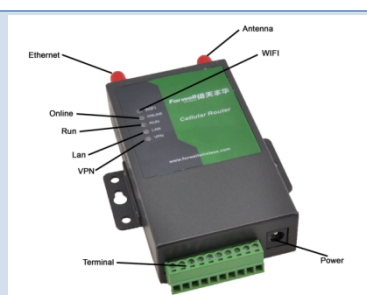

Online	On	Access to the Internet	
WIFI	On	Enable	
	Off	Disable	

Chapter 4 Software configuration

1. *Overview*
2. *How to log into the Router*
3. *How to config web*

4.1 Overview

R4 series routers with built-in WEB interface configuration, management and debugging tools, user should configure the parameters first;and it could be altered the parameters flexibility and software upgrades and simple testing. user can set up and manage the parameters of the router on its interface ,detail step as belows .:

4.2 How to log into the Router

4.2.1 network Configuration of the Computer.

The router default parameters as follow

IP: 10.10.10.254, sub mask: 255.255.255.0.

There are two ways to set the PC's IP address.

1. **Manual setting**
Set the PC IP as 10.10.10.xxx (xxx = 1~253), subnet mask: 255.255.255.0, default gateway: 10.10.10.254, primary DNS: 10.10.10.254.
2. **DHCP**
Choose "Obtain an IP address automatically" and "Obtain DNS server address automatically".
After IP setting, check it by ping. Click Windows start menu, run, execute "cmd" command. Input "ping 10.10.10.254" in the DOS window.

```
C:\>ping 10.10.10.254

Pinging 10.10.10.254 with 32 bytes of data:

Reply from 10.10.10.254: bytes=32 time<1ms TTL=64
Reply from 10.10.10.254: bytes=32 time<1ms TTL=64
Reply from 10.10.10.254: bytes=32 time<1ms TTL=64
Reply from 10.10.10.254: bytes=32 time<1ms TTL=64

Ping statistics for 10.10.10.254:
    Packets: Sent = 4, Received = 4, Lost = 0 (0% loss),
    Approximate round trip times in milli-seconds:
        Minimum = 0ms, Maximum = 0ms, Average = 0ms
```

This information means the connection is ok.

```
C:\>ping 10.10.10.254

Pinging 10.10.10.254 with 32 bytes of data:

Request timed out.
Request timed out.
Request timed out.
Request timed out.

Ping statistics for 10.10.10.254:
    Packets: Sent = 4, Received = 0, Lost = 4 (100% loss),
```

This information means the connection is failure. If so, please check the network cable connection and IP address setting.

4.2.2 log into Router

- Open the Web browser, and type `http://10.10.10.254` into the address field and press Enter button in your computer keyboard.
- Type User Name "admin" and Password "admin" in the pop-up Login Window, and then press the "Apply" button.



- If you type into the correct User Name and Password, you will get the access into the Router's Web Management Page.

Forwell 倚天丰华
无限创造自由

[open all](#) | [close all](#)

- 3G Router
 - Operation Mode
 - Internet Settings
 - WAN
 - LAN
 - Advanced Routing
 - VPN
 - DTU
 - SMS/Voice Command
 - Status Report
 - Route Fail Over
 - Wireless Settings
 - Basic
 - Advanced
 - Security
 - WDS
 - WPS
 - Station List
 - Firewall
 - MAC/IP/Port Filtering
 - Port Forwarding
 - DMZ
 - System Security
 - Content Filtering
 - Administration
 - Management
 - Reboot
 - Upload Firmware
 - Settings Management
 - Status**
 - Statistics
 - System Log

Access Point Status

Let's take a look at the status of 3G Router.

System Info	
Product Model	3G Router
Software Version	1.4.33 (Apr 9 2011)
Hardware Version	1.0.0
Device ID	2C148006E0091100
System Up Time	19 hours, 25 mins, 35 secs
Operation Mode	Gateway Mode
3G Info	
Signal Strength	open device error!
Attachment State	WCDMA PREFERRED
Local Network	
Local IP Address	192.168.1.1
Local Netmask	255.255.255.0
MAC Address	00:10:18:01:02:9C
Internet Configurations	
Connected Type	3G
WAN IP Address	
Subnet Mask	
Default Gateway	
Primary Domain Name Server	
Secondary Domain Name Server	
MAC Address	00:10:18:01:0E:64

4.3 config through web

4.3.1 Main Menu as below Picture

Forwell 倚天丰华 无限创造自由

open all | close all

Access Point Status

Let's take a look at the status of 3G Router.

System Info	
Product Model	3G Router
Software Version	1.4.33 (Apr 9 2011)
Hardware Version	1.0.0
Device ID	2C148006E0091100
System Up Time	19 hours, 25 mins, 35 secs
Operation Mode	Gateway Mode

3G Info	
Signal Strength	open device error!
Attachment State	WCDMA PREFERRED

Local Network	
Local IP Address	192.168.1.1
Local Netmask	255.255.255.0
MAC Address	00:10:18:01:02:9C

Internet Configurations	
Connected Type	3G
WAN IP Address	
Subnet Mask	
Default Gateway	
Primary Domain Name Server	
Secondary Domain Name Server	
MAC Address	00:10:18:01:0E:64

4.3.2 Operation Mode

Forwell 倚天丰华 无限创造自由

open all | close all

Operation Mode Configuration

You may configure the operation mode suitable for you environment.

Bridge:
 All ethernet and wireless interfaces are bridged into a single bridge interface.

Gateway:
 The first ethernet port is treated as WAN port. The other ethernet ports and the wireless interface are bridged together and are treated as LAN ports.

AP Client:
 The wireless apcli interface is treated as WAN port, and the wireless ap interface and the ethernet ports are LAN ports.

NAT Enabled

Apply Cancel

- **Bridge:** All ethernet and wireless interfaces are bridged into a single bridge interface.
- **Gateway:** The first Ethernet port is treated as WAN port. The other

Ethernet ports and the wireless interface are bridged together and are treated as LAN ports.

- **AP Client:** The wireless interface is treated as WAN port and the wireless AP interface and the Ethernet ports are LAN ports.
- **NAT:** Network Address Translation

4.3.3 WAN Settings

The screenshot displays the WAN Settings interface for a Forwell wireless router. The interface is in Chinese and English. The top header includes the Forwell logo and the slogan '无限创造自由'. The left sidebar shows a tree view of settings, with 'WAN' selected under 'Internet Settings'. The main content area is titled 'WAN Connection Type' and is set to '3G'. Below this, there are sections for '3G Mode' and 'MAC Clone'. The '3G Mode' section includes fields for 'USB 3G modem' (set to HUAWEI-EM660), '3G SIM Code', and 'MTU'. The 'Operation Mode' is set to 'Keep Alive'. The 'MAC Clone' section has an 'Enabled' checkbox and a dropdown menu set to 'Disable'. 'Apply' and 'Cancel' buttons are at the bottom.

- WAN Connection Type support: Static IP, DHCP, PPPoE, L2TP, PPTP, 3G.
- USB Modem: System supports the follow module: HUAWEI EM560 (for R88 TD-SCDMA), HUAWEI EM660/THINKWILL MI600(for R86 EVDO), and HUAWEI EM770/LONGSUNG-U6300/U5300(for R89 HSPA). Please choose right USB modem.
- 3G SIM PIN: enter PIN code if necessary.
- Operation Mode: always online, connect on demand, connect on time. The default mode is always on line.
- MAC Clone: enable and disable the MAC clone function.

mobile MSP Parameters	
MSP Name	WCDMA
3G network type	WCDMA PREFERRE ▾
Dialing Number	*99#
Initial Command String	at+cgdcont=1,\"IP\", \"3gnet\",
User Name	wap
Password	●●●
Local IP	
Authenticate Type	AUTO ▾
Use Software Compress	<input type="checkbox"/> Enable
<input type="button" value="Add to List"/>	

- **Mobile MSP parameters:** edit the MSP parameters.
- **MSP Name:** any name is ok
- **3G network type:** you can choose right network here.
- **Dialing Number:** Input the Dialing Number you get from ISP. For example, China Telecom (#777)
- **Initial Command String:** you need to input the username and password or APN offered by ISP with our Initial command
 - R46 EVDO:** please input: `at^pppcfg=\"username\", \"password\"` Take China Telecom (both username and password are "CARD") as a sample: we input this command `at^pppcfg=\"CARD\", \"CARD\"`
(HUAWEI_EM660/Thinkwill MI600)
 - R47/R49 HSPA:** `at+cgdcont=1,\"IP\", \"APN\",` Take China Mobile (Their APN is 3gnet) as a sample: we input this command `at+cgdcont=1,\"IP\", \"3gnet\",`
(HUAWEI_EM770/U5300/U6300/GaoRan280)
 - R42a GPRS:** `at+cgdcont=1,\"IP\", \"APN\",` as a sample: we input this command `at+cgdcont=1,\"IP\", \"cmnet\",`
 - R43a CDMA:** `at+zpidpwd=username,password` , as a sample: we input this command `at+zpidpwd=card,card`
- **Username and Password:** input them.
- **Authenticate Type:** PAP/CHAP, the default setting is auto.

MSP List							
No.	MSP Name	Dialing Number	Initial Command String	User Name	Password	Local IP	Operation
<input type="radio"/>	CDMA	#777		CARD	CARD		Delete
<input checked="" type="radio"/>	WCDMA	*99#		wap	wap		Delete
<input type="radio"/>	TD-SCDMA	*99***1#		wap	wap		Delete

Select to Use

MSP list: This list is produced automatically once you finish the above mobile MSP parameters. just choose the right MSP parameters and corresponding module(3G USB modem), and click Apply, then it will dial.

For example, we use R49 HSPA router to dial:

The screenshot shows the router's configuration interface. On the left is a tree view with 'Internet Settings' expanded to 'WAN'. The main area is divided into sections:

- WAN Connection Type:** Set to '3G'.
- 3G Mode:** Includes fields for 'USB 3G modem' (HUAWEI-EM770), '3G SIM Code', 'MTU', and 'Operation Mode' (Keep Alive).
- MAC Clone:** 'Enabled' is set to 'Disable'.
- mobile MSP Parameters:**
 - 'MSP Name': WCDMA
 - '3G network type': Automatic search
 - 'Dialing Number': *99# (circled in red)
 - 'Initial Command String': at+cgdcont=1,\"IP\",\"3gnet\" (circled in red)
 - 'User Name': wap
 - 'Password': masked with dots

Annotations include:

- 'Third,click apply' pointing to the 'Apply' button.
- 'First,input the dial number and initial Command String.' pointing to the 'Dialing Number' and 'Initial Command String' fields.
- 'click this button after you finish the paremeters' pointing to the 'Add to List' button.
- 'Second:choose the right MSP Name you have finished in first step,and click Select to Use button.' pointing to the 'WCDMA' row in the MSP List table.

The 'MSP List' table at the bottom of the screenshot is identical to the one shown in the first image:

No.	MSP Name	Dialing Number	Initial Command String	User Name	Password	Local IP	Operation
<input type="radio"/>	CDMA	#777		CARD	CARD		Delete
<input checked="" type="radio"/>	WCDMA	*99#		wap	wap		Delete
<input type="radio"/>	TD-SCDMA	*99***1#		wap	wap		Delete

Select to Use

4.3.4 LAN Settings

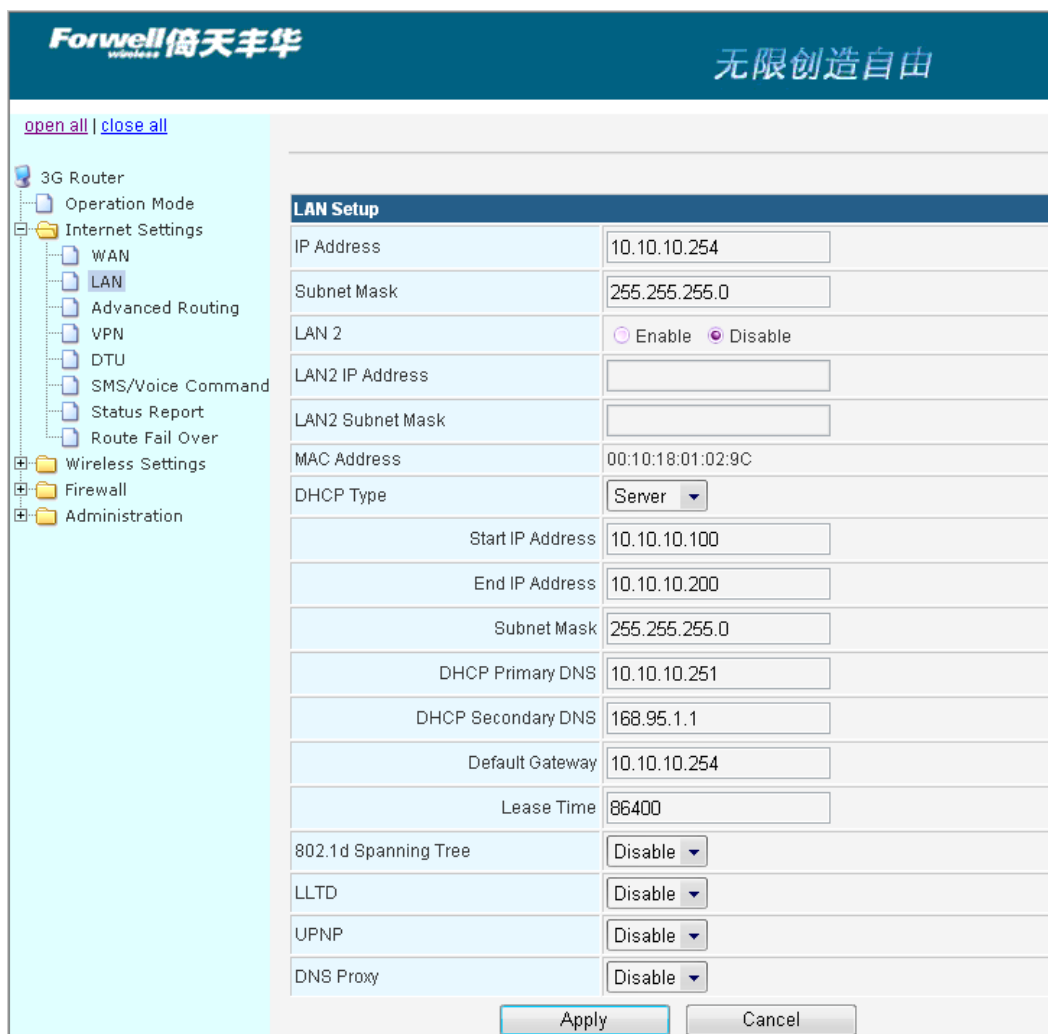

Setting the LAN parameters, include IP address, sub mask, VLAN, DHCP, etc.

4.3.5 DHCP Client

DHCP Client List

You could monitor DHCP clients here.

DHCP Clients			
Hostname	MAC Address	IP Address	Expires in

List the Clients which gain IP address from DHCP .

4.3.6 Configure Static Routing

This section mainly introduce what is Routing Table and how to configure

static router.

- **Routing Table**

This page shows the key routing table of this router.

Current Routing table in the system:									
No.	Destination	Netmask	Gateway	Flags	Metric	Ref	Use	Interface	Comment
1	255.255.255.255	255.255.255.255	0.0.0.0	5	0	0	0	LAN(br0)	
2	10.10.10.0	255.255.255.0	0.0.0.0	1	0	0	0	LAN(br0)	

- **New Static Router**

This page is about how to set static routing function of the router.

Add a routing rule	
Destination	<input type="text"/>
Range	Host <input type="button" value="v"/>
Gateway	<input type="text"/>
Interface	LAN <input type="button" value="v"/> <input type="text"/>
Comment	<input type="text"/>

§ **Destination:** please enter Target Host or IP network segment

§ **Range:** Host or Network can be chosen

§ **Gateway:** IP address of the next router.

§ **Interface:** You can choose the corresponding interface type.

§ **Comment:** some notes

Notice:

- Gateway and LAN IP of this router must belong to the same network segment.
- If the destination IP address is the one of a host, and then the Subnet Mask must be 255.255.255.255.
- If the destination IP address is IP network segment, it must match with the Subnet Mask. For example, if the destination IP is 10.0.0.0, and the Subnet Mask is 255.0.0.0.

4.3.7 VPN

4.3.7.1 IPSEC

Ipsec VPN

Using IPsec protocol to achieve remote access.

IPSEC Vpn List						
No.	State	Name	service mode	Remote Gateway	Local Address	Remote Address
1	<input checked="" type="checkbox"/>	jordan	client	195.8.171.180	192.168.1.0	10.10.10.0

IPSec connect name
you can input DEV+DeviceID+[...] to bind device
 example:DEV281250D52F2A1452.vpn1.com

service mode

Mode

Remote IPsec gateway

Local IP address

VPN IP address

IP subnet mask

Remote IP address

VPN IP address

IP subnet mask

Key Exchange Method

Authentication

Pre-Shared Key

Perfect Forward Secrecy

NAT Traversal

Advanced IKE Settings

- **IPsec connect name:** make sure the name in client and server are same, we suggest to use domain name(111.vpn1.com). if you want to build a point-to-point channel, the IPsec name have to be written as DEV+equipment ID+name(DEV281250D52F2A1452.vpn1.com), and make sure both the client and server are inputting Client equipment ID. You can find R8's ID in the Status interface.

- **Service Mode:** Server/Client
- **Mode:** Main/Aggressive. The Aggressive mode is commonly used.
- **Remote Gateway:** This choice just appears in the Client mode and it is used to fill the IP address in the Server.
- **Local IP address:** Fill LAN IP of this device. You can fill an IP or a network segment.
- **Remote IP address:** Fill the IP of the other router.
- **Authentication:** Commonly, Pre-Shared Key is chosen. And the Client and Server must choose the same key.
- **Advanced AKE settings:** There are some encryption methods in this field. You must use the settings in this field when VPN tunnel needs to be built between R8 and other brand VPN server.
- **Example: Connected cisco 7200 and R4**

How to config R4 as VPN client

IPsec Name: make sure the name in client and server are same, we suggest to use domain name(111.vpn1.com). if you want to build a point-to-point channel, the IPsec name have to be written as DEV+equipment ID+name(DEV281250D52F2A1452.vpn1.com), and make sure both the client and server are inputting Client equipment ID. You can find R8's ID in the Status interface.

IPSec connect name	jordan <small>you can input DEV+DeviceID+[...] to bind device example:DEV281250D52F2A1452.vpn1.com</small>
service mode	client
Mode	Aggressive
Remote IPSec gateway	195.8.171.180
Local IP address	Subnet
VPN IP address	192.168.1.0
IP subnet mask	255.255.255.0
Remote IP address	Subnet
VPN IP address	10.10.10.0
IP subnet mask	255.255.255.0
Key Exchange Method	Auto (IKE)
Authentication	Pre-Shared Key
Pre-Shared Key	●●●●●●●●
Perfect Forward Secrecy	Enable
NAT Traversal	<input checked="" type="checkbox"/>

Advanced IKE Settings Hide Advanced Settings

Phase 1

Encryption 3DES

Integrity Algorithm SHA1

Select Diffie-Hellman Group for Key Exchange 1024bit

Key Lifetime 3600 Seconds

Phase 2

Encryption 3DES

Integrity Algorithm SHA1

Select Diffie-Hellman Group for Key Exchange 1024bit

Key Lifetime 28800 Seconds

Apply Cancel

How to config cisco 7200 as VPN Server

```
crypto keyring jordan
pre-shared-key hostname jordan key test
```

```
crypto isakmp profile jordan
description china SZ shenzhen
keyring jordan
match identity host jordan
keepalive 60 retry 10
```

```
crypto ipsec transform-set vpnset esp-des esp-sha-hmac
```

```
crypto ipsec profile jordan
set transform-set vpnset
set isakmp-profile jordan
```

```
crypto dynamic-map jordan 1
set security-association lifetime kilobytes 536870912
set security-association lifetime seconds 43200
set transform-set vpnset
set isakmp-profile jordan
reverse-route
crypto map COREVPN 26 ipsec-isakmp dynamic jordan
```

4.3.7.2 PPTP

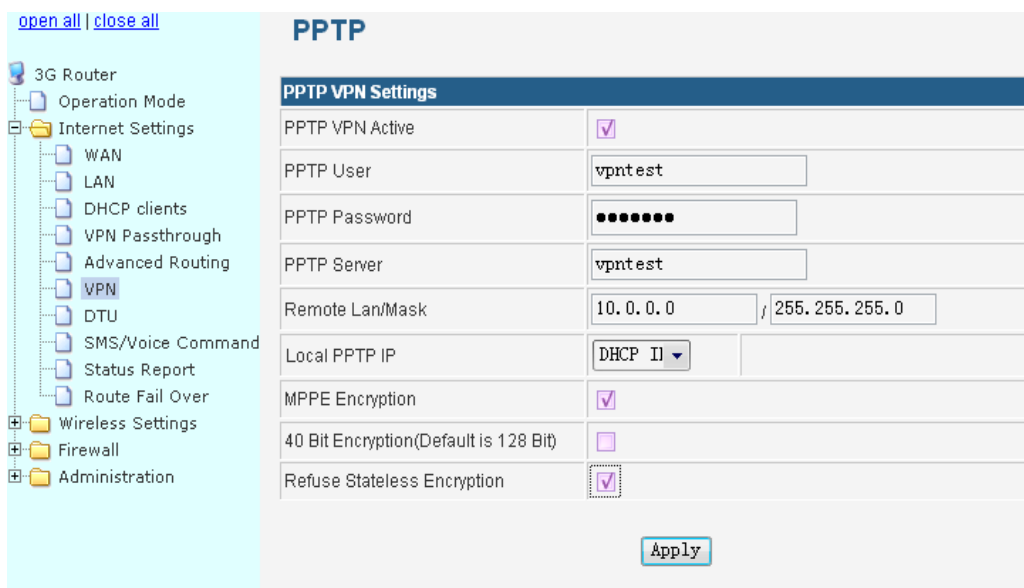

this function in the device just works as Client.

4.3.7.3 L2TP

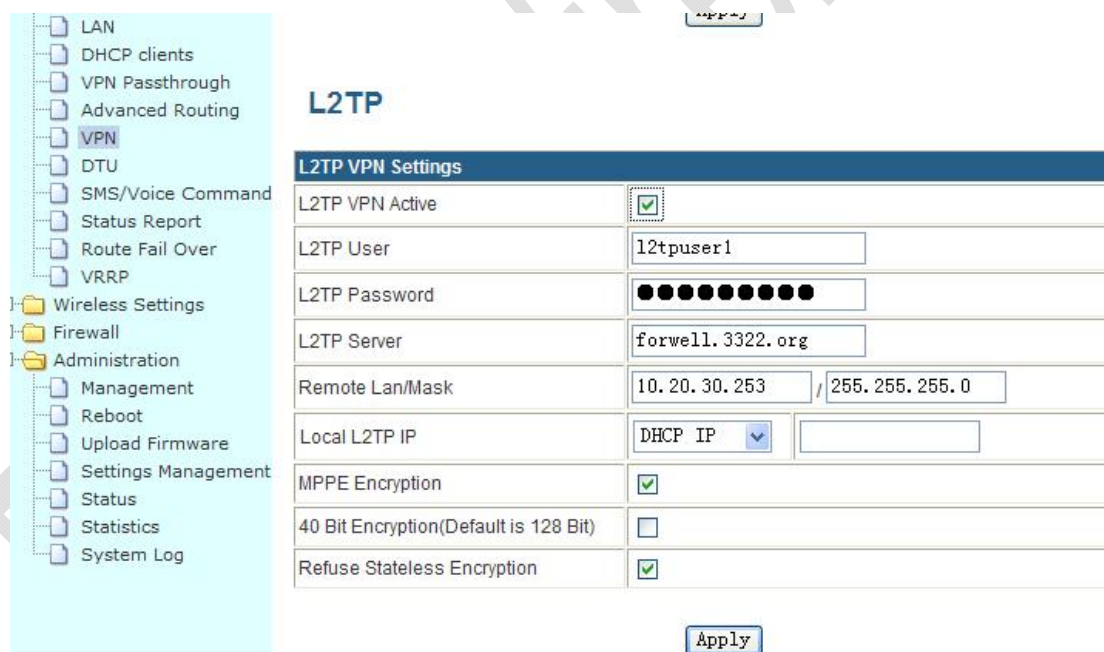

this function in the device just works as Client.

4.3.8 DTU Settings

DTU Status Table	
dtu status	on ▾
DTU Serial Settings Table	
baudrate	9600 ▾ bps
parity	none ▾
databits	8 ▾ bits
stopbits	1 ▾ bits
flow control	none ▾
DTU config Table	
link type	client ▾
network type	tcp ▾
server 1	<input checked="" type="checkbox"/> 113.111.127.22 : 8000
server 2	<input type="checkbox"/> :
server 3	<input type="checkbox"/> :
server 4	<input type="checkbox"/> :
heart beat time	10 s (0 means disable)
heart beat infomation	hex <input type="checkbox"/> hello dtu
off heart beat when no serial data	<input type="checkbox"/>
off heart beat delay time	s
send data timeout	100 ms (0~999)

apply

This section is mainly about DTU settings.

- **DTU status:** open and close DTU
- **Baudrate:** support 4800/9600/19200/38400/57600/115200bps
- **Link Type:** Server link or Client link can be chosen in the DTU config table. If use it as Server, we suggest you to use fixed IP of the SIM card.
- **Multiple-path Backup:** the router can support 4 Server IP at most to meet the need for multiple-path data backup.
- **Heart Beat function:** You can define heart beat time and heat beat information. So that Server can use the heart beat information to identify DTU.
- **Data content:** the largest package contents are 3KB. The interval between packets can be adjusted through change “send data timeout”.

4.3.9 SMS/Voice Control (it is only used for R46B/R49B)

SMS/Voice Settings

SMS/Voice Table	
SMS/Voice status	on ▾
Send response message	on ▾
Voice Command	3G Link Down ▾
Telephone Numbers	
Number 1	13688888888 <input checked="" type="checkbox"/> SMS
Number 2	<input type="text"/> <input type="checkbox"/> SMS
Number 3	<input type="text"/> <input type="checkbox"/> SMS
Number 4	<input type="text"/> <input type="checkbox"/> SMS
Number 5	<input type="text"/> <input type="checkbox"/> SMS
Number 6	<input type="text"/> <input type="checkbox"/> SMS
Number 7	<input type="text"/> <input type="checkbox"/> SMS
Number 8	<input type="text"/> <input type="checkbox"/> SMS
Number 9	<input type="text"/> <input type="checkbox"/> SMS
Number 10	<input type="text"/> <input type="checkbox"/> SMS
Message Command Settings	
3G Link-up Command	up
3G Link-down Command	down

This section is to introduce how to wake up the router from SMS or Voice.

- **SMS/Voice status:** open(on) or close(off) this function.
- **Send respond SMS:** When the router receive a message, it will reply one piece if you choose "on"..
- **Voice Command:** 4 choices(close, 3G link up, 3G link down, 3G link up or down); perform the corresponding action according to what you have chosen. (Note:at present, Voice function do not support phone number filtering.)
- **Telephone Number Settings:** 10 numbers can be set at most, which you can send SMS from these phone numbers.
- **Command Settings:** Sending order by mobile phone can open "3G link up" and "3G link down".

Note: SIM Card inserted in the router must support SMS or Voice.

4.3.10 GPS(OPTIONAL)

Due to different application requirements, R4 3G takes all these special requirements into consideration, so R4 3G provide you GPS service. Detailed settings as below:

GPS

GPS Settings	
GPS Active	<input checked="" type="checkbox"/>
GPS Send to	<input type="radio"/> Serial <input checked="" type="radio"/> TCP/IP
GPS To Serial Settings	
Serial Baudrate	115200 bps
Serial Parity	none
Serial Databits	8 bits
Serial Stopbits	1 bits
Serial Flow Control	none
Comment: Do not used GPS with DTU when send to serial!	
GPS To TCP/IP Settings	
Socket Type	tcp
Server	10.0.0.188
Port	5000

- GPS Settings: 1.GPS Action:enable/disable
2.GPS Send to:Serial or TCP/IP
- Serial Settings: 1.Baudrate:default 115200
2.Parity:default none
3.Datebit:default 8
4.Stopbits:default 1
5.Flow Control:default none
- GPS To TCP/IP Settings: 1.Socket Type:TCP/UDP
2.Server:Server IP address
3.Port:Server Port

4.3.11 Wirless settings

4.3.11.1 Basic Wireless Settings

Wireless Network	
Radio On/Off	<input type="button" value="RADIO OFF"/>
Network Mode	11b/g/n mixed mode ▾
Network Name(SSID)	Forwell <input type="checkbox"/> Hidden <input type="checkbox"/> Isolated
Multiple SSID1	<input type="text"/> <input type="checkbox"/> Hidden <input type="checkbox"/> Isolated
Multiple SSID2	<input type="text"/> <input type="checkbox"/> Hidden <input type="checkbox"/> Isolated
Multiple SSID3	<input type="text"/> <input type="checkbox"/> Hidden <input type="checkbox"/> Isolated
Multiple SSID4	<input type="text"/> <input type="checkbox"/> Hidden <input type="checkbox"/> Isolated
Multiple SSID5	<input type="text"/> <input type="checkbox"/> Hidden <input type="checkbox"/> Isolated
Multiple SSID6	<input type="text"/> <input type="checkbox"/> Hidden <input type="checkbox"/> Isolated
Multiple SSID7	<input type="text"/> <input type="checkbox"/> Hidden <input type="checkbox"/> Isolated
Broadcast Network Name (SSID)	<input checked="" type="radio"/> Enable <input type="radio"/> Disable
AP Isolation	<input type="radio"/> Enable <input checked="" type="radio"/> Disable
MBSSID AP Isolation	<input type="radio"/> Enable <input checked="" type="radio"/> Disable
BSSID	00:10:18:01:05:34
Frequency (Channel)	2437MHz (Channel 6) ▾

The basic parameters of Wi-Fi setting.
 The Radio function enable and disable.
 The network mode supports 802.11 b/g/n (draft).
 Support multi-SSID up to 8.

4.3.11.2 Wireless Security/Encryption Settings

Select SSID	
SSID choice	Forwell ▾

"Forwell"	
Security Mode	Disable ▾

Access Policy	
Policy	Disable ▾
Add a station Mac:	<input type="text"/>

The SSID select from multi-SSID setting.
 Security mode include: disable, open, share, wep auto, WPA, wpa-psk, wpa2,

wpa2-psk, wpa-psk/wpa2-psk, wpa/wpa2, 802.1X.
 Access policy: setting the MAC list for access or deny.

4.3.12 Firewall

4.3.12.1 MAC/IP/Port Filter Settings

Basic Settings

MAC/IP/Port Filtering	Disable ▾
Default Policy -- The packet that don't match with any rules would be:	Dropped ▾

MAC/IP/Port Filter Settings

MAC address	<input type="text"/>
Dest IP Address	<input type="text"/>
Source IP Address	<input type="text"/>
Protocol	None ▾
Dest Port Range	<input type="text"/> - <input type="text"/>
Source Port Range	<input type="text"/> - <input type="text"/>
Action	Accept ▾
Comment	<input type="text"/>

(The maximum rule count is 32.)

Current MAC/IP/Port filtering rules in system:

No.	MAC address	Dest IP Address	Source IP Address	Protocol	Dest Port Range	Source Port Range	Action	Comment	Pkt Cnt
Others would be dropped									-

This section is mainly about MAC/IP/Port filter settings

- **Basic Settings:** Open the filter setting and set the filtering principle.
- **MAC address:** Fill the MAC address which needs to filter.
- **Destination IP:** IP of the target computer(the computer which the data packet will be sent to)
- **Destination Port Range:** port range of target computer
- **Source Port Range:** port range of the computer which sends data

4.3.12.2 Port Forwarding

Virtual Server Settings	
Virtual Server Settings	Enable ▾
IP Address	<input type="text"/>
Port Range	<input type="text"/> - <input type="text"/>
Protocol	TCP&UDP ▾
Comment	<input type="text"/>

(The maximum rule count is 32.)

Current Virtual Servers in system:				
No.	IP Address	Port Range	Protocol	Comment
1 <input type="checkbox"/>	192.168.1.123	9000 - 9000	TCP + UDP	

Port forwarding is the process that your router or firewall uses to sort the right kind of network data to the right port. Computers and routers use ports as a way to organize network data. Different types of data, such as web sites, file downloads, and online games, are each assigned a port number. By using port forwarding, the router or firewall sends the correct data to the correct place.

- Virtual Server Settings: open and close Settings.
- IP address: fill the IP address of forwarding.
- PortRange: fill the Port of forwarding.

4.3.12.3 DMZ Host

DMZ Settings	
DMZ Settings	Enable ▾
DMZ IP Address	<input type="text"/>

In computer networking, DMZ is a firewall configuration for securing local area networks (LANs).

- DMZ Settings: open and close Settings.
- DMZ host IP Address: Please Enter the IP address of the computer which you want to set as DMZ host

Note: When DMZ host is setted, the computer is completely exposed to the external network, the firewall will not influence this host.

4.3.12.4 System Security

Remote management	
Remote management (via WAN)	Allow ▾
Ping form WAN Filter	
Ping form WAN Filter	Disable ▾
Stateful Packet Inspection (SPI)	
SPI Firewall	Disable ▾

Include Remote management, Ping from WAN Filter and SPI(Stateful Packet Inspection).

4.3.12.5 Content Filter Settings

Webs Content Filter	
Filters:	<input type="checkbox"/> Proxy <input type="checkbox"/> Java <input type="checkbox"/> ActiveX
Add a URL filter:	
URL:	<input type="text"/>
Add a Host(keyword) Filter:	
Keyword	<input type="text"/>

You can setup Content Filter to restrict the improper content access, including Webs Content Settings, URL filter and Host Filter.

4.3.13 Administration

4.3.13.1 Management

Language Settings	
Select Language	English
Adminrator Settings	
Account	admin
Password	•••••
NTP Settings	
Current Time	Sat Jan 1 00:02:42 UTC 2000 <input type="button" value="Sync with host"/>
Time Zone:	(GMT+08:00) China Coast, Hong Kong
NTP Server	<input type="text"/> ex: time.nist.gov ntp0.broad.mit.edu time.stdtime.gov.tw
NTP synchronization(hours)	<input type="text"/>

- Select Language
- Adminrator Settings. The default both are admin.
- NTP Settings

DDNS Settings	
Dynamic DNS Provider	Dyndns.org
Account	<input type="text"/>
Password	<input type="text"/>
DDNS	<input type="text"/>

DDNS: Dyndns.org/freedns.afraid.org/www.zoneedit.com/www.no-ip.com support

4.3.13.2 Reboot Settings

ICMP check and Reboot Settings	
Reboot When Network Error	<input checked="" type="checkbox"/>
Check Method(PING)	www.forwellwirel <input type="button" value="check"/>
	www.baidu.com <input type="button" value="check"/>
Check Interval Time(Sec)	60 (60-86400)
Check Count	5 (3-1000)
Reboot Count Before Sleep	3 (2-50)
Sleep Time(min)	60 (10-43200)
Comment: It is only used for 3G keep_alive and on_time mode,It is auto close in other mode!	
<input type="button" value="Apply"/>	

This function will detect the status of 3G by ping and complete the corresponding actions according to the ping result.

- Check the box, start the net detection restart function.
- Detection method (PING): fill the server domain name or IP, and then click the detection button, and detect if the fill-in is right.
- Detection interval time (second): the interval time between the first detection and the second detection is 60-86400 seconds.
- Detection counter: if you can't get the right result by ping when the detection frequency is the same as the fill-in times, the device will restart.
- Restart the counter before the detection function get into dormant state & detection function dormant time: this will protect the device against the damage caused by the continuous restarts, which are caused by the ping failure by the result of the fault in filling the server domain name. After several times of restarts, the device will get into the dormant state. After that the detection will continue, and now the counter in flash will become zero and recount.

Note: This function will be only valid only in 3G permanent on-line and dialing according to the setting time, other states not. In setting, firstly you must detect if the filled-in server domain name or IP is valid.

4.3.13.3 Upgrade Firmware

Update Firmware	
Location:	<input type="text"/> <input type="button" value="浏览..."/>

Upgrade the firmware to obtain new functionality. It takes about 2 minutes.

4.3.13.4 Parameter Management

Export Settings	
Export Button	<input type="button" value="Export"/>

Import Settings	
Settings file location	<input type="text"/> <input type="button" value="浏览..."/>
<input type="button" value="Import"/> <input type="button" value="Cancel"/>	

Load Factory Defaults	
Load Default Button	<input type="button" value="Load Default"/>

Here you can make a backup of current settings or restore previous settings of the router .

- **Export settings:** click 'export' to export configuration files and then select save path.
- **Import settings:** click 'browse', select previous backup configuration files and then click 'Import'. Then all the previous settings will be recovered.
- **Load Factory Defaults:** click 'Load Default' then all settings will be restored to factory settings. This is not recommended in order to avoid the loss of important parameter

4.3.13.5 System state information

The screenshot shows the 'Access Point Status' page of a Forwell 3G Router. The page is divided into several sections:

- System Info:**

Product Model	3G Router
Software Version	1.4.33 (Apr 9 2011)
Hardware Version	1.0.0
Device ID	2C148006E0091100
System Up Time	19 hours, 25 mins, 35 secs
Operation Mode	Gateway Mode
- 3G Info:**

Signal Strength	open device error!
Attachment State	WCDMA PREFERRED
- Local Network:**

Local IP Address	192.168.1.1
Local Netmask	255.255.255.0
MAC Address	00:10:18:01:02:9C
- Internet Configurations:**

Connected Type	3G
WAN IP Address	
Subnet Mask	
Default Gateway	
Primary Domain Name Server	
Secondary Domain Name Server	
MAC Address	00:10:18:01:0E:64

From the this page you can see the Router's basic running state.

- **Product Model**
- **Software Version:** software version reveals the status of software update.
- **Hardware Version: 1.0.0**
- **Device ID:** every device has a unique ID, which has two functions: 1, it is manageable; 2, it allows to use point to point in VPN.
- **System Uptime:** this time directly reveals router working hours.
- **Signal Strength:** reveals the current network state of 2G/3G. 0 and 99 mean no signal.
- **Attachment state:** displays the current network attachment state, which can be set by users.
- **WPN IP address:** the IP expose when the router gets on internet.

4.3.13.6 Flow Statistics

WAN/LAN	
WAN Rx packets:	0
WAN Rx bytes:	0
WAN Tx packets:	18
WAN Tx bytes:	1476
LAN Rx packets:	1063
LAN Rx bytes:	100996
LAN Tx packets:	572
LAN Tx bytes:	440808

Display the statistics information of system flow.

4.3.13.7 System log

```
System Log
Jan 1 00:00:22 kernel: dwc_otg lm0: DWC OTG Controller
Jan 1 00:00:22 kernel: drivers/usb/core/inode.c: creating file 'devices'
Jan 1 00:00:22 kernel: drivers/usb/core/inode.c: creating file '001'
Jan 1 00:00:22 kernel: dwc_otg lm0: new USB bus registered, assigned bus
Jan 1 00:00:22 kernel: dwc_otg lm0: irq 18, io mem 0x00000000
Jan 1 00:00:22 kernel: DWC_otg: Init: Port Power? op_state=1
Jan 1 00:00:22 kernel: DWC_otg: Init: Power Port (0)
Jan 1 00:00:22 kernel: usb usb1: default language 0x0409
Jan 1 00:00:22 kernel: usb usb1: new device strings: Mfr=3, Product=2, S
Jan 1 00:00:22 kernel: usb usb1: Product: DWC OTG Controller
Jan 1 00:00:22 kernel: usb usb1: Manufacturer: Linux 2.6.21 dwc_otg_hcd
Jan 1 00:00:22 kernel: usb usb1: SerialNumber: lm0
Jan 1 00:00:22 kernel: usb usb1: usb_probe_device
Jan 1 00:00:22 kernel: usb usb1: configuration #1 chosen from 1 choice
Jan 1 00:00:22 kernel: usb usb1: adding 1-0:1.0 (config #1, interface 0)
Jan 1 00:00:22 kernel: hub 1-0:1.0: usb_probe_interface
Jan 1 00:00:22 kernel: hub 1-0:1.0: usb_probe_interface - got id
Jan 1 00:00:22 kernel: hub 1-0:1.0: USB hub found
Jan 1 00:00:22 kernel: hub 1-0:1.0: 1 port detected
Jan 1 00:00:22 kernel: hub 1-0:1.0: standalone hub
Jan 1 00:00:22 kernel: hub 1-0:1.0: ganged power switching
Jan 1 00:00:22 kernel: hub 1-0:1.0: individual port over-current protect
Jan 1 00:00:22 kernel: hub 1-0:1.0: Single TT
Jan 1 00:00:22 kernel: hub 1-0:1.0: TT requires at most 8 FS bit times (
Jan 1 00:00:22 kernel: hub 1-0:1.0: power on to power good time: 2ms
Jan 1 00:00:22 kernel: hub 1-0:1.0: local power source is good
Jan 1 00:00:22 kernel: hub 1-0:1.0: enabling power on all ports
Jan 1 00:00:22 kernel: drivers/usb/core/inode.c: creating file '001'
Jan 1 00:00:22 kernel: nf_contrack version 0.5.0 (256 buckets, 2048 max
Jan 1 00:00:22 kernel: IPv4 over IPv4 tunneling driver
```

From the system log you can read the various situations after the system starts.